

AOYUE[®]
INT 2703A+

**Advanced Lead-Free
Repairing System**

INSTRUCTION MANUAL

Thank you for purchasing Aoyue Int2703A+ Repairing System.
It is important to read the manual before using the equipment.
Please keep manual in accessible place for future reference.



Manufacturer:
AOYUE TONGYI ELECTRONIC EQUIPMENT FACTORY
Jishui Industrial Zone, Nantou, Zhongshan City,
Guangdong Province, P.R.China
<http://www.aoyue.com>

This manual is designed to familiarize and instruct the operator with the proper usage and maintenance of the equipment. The "Care and Safety Precautions" section explains the hazards of using any type of soldering or reworking device. Please read carefully and observe the guidelines in order to maximize usage and minimize the risk of injury or accidents .

TABLE OF CONTENTS

Product Description	3
Specifications	4
Package Inclusion	5
Functions and Features	6
Safety Precautions	7
Assembly and Preparation	8
Control Panel Guide	9
Operating Guidelines	10—17
Auto-Sleep Functions	18—20
Digital Calibration	21—23
Care and Maintenance	24—26
Basic Troubleshooting Guide	27—29
Replacement Tips	30
Air Nozzles	31

REPLACEMENT AIR NOZZLES

Straight Single

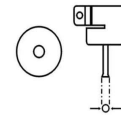

Nozzle Model	Nozzle Size, φ (mm)
1124	2.5
1130	4.4
1194	6
1195	8
1196	7
1197	9
1198	12

Bent Single

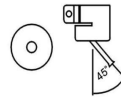

Nozzle Model	1142

Dual Single Adjustable

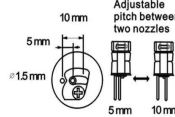

Nozzle Model	1325

Single In Line Package

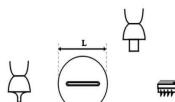

Nozzle Model	IC Package Size	Nozzle Length (mm)	
		SIP 25L	SIP 50L
1191	SIP 25L	26	
1192	SIP 50L	52.5	

Ball Grid Array

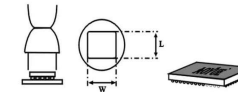

Nozzle Model	IC Package Size (mm)	Nozzle Size (mm)	
		W	L
1010	BGA 9x9	10	10
1313	BGA 12x12	13	13
1616	BGA 15x15	16	16
1919	BGA 18x18	19	19
2828	BGA 27x27	28	28
3636	BGA 35x35	36	36
3939	BGA 38x38	39	39
4141	BGA 40x40	41	41

Small Outline J-Lead



Nozzle Model	IC Package Size (mm)	Nozzle Size (mm)	
		L	W
1183	SOJ 15x8	16	8
1184	SOJ 18x8	19	10
1214	SOJ 10x26	25.9	12

Plastic Leaded Chip Carrier

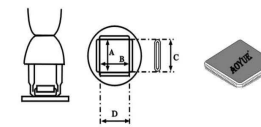

Nozzle Model	IC Package Size (mm)	Nozzle Size (mm)			
		A	B	C	D
1135	PLCC 17.5x17.5 (44pins)	18.5	18.5	15	15
1136	PLCC 20x20 (52pins)	21	21	19	19
1137	PLCC 25x25 (68pins)	26	26	24	24
1138	PLCC 30x30 (84pins)	31	31	29	29
1139	PLCC 7.3x12.5 (18pins)	9	14	69	69
1140	PLCC 11.5x11.5 (28pins)	13	13	15	10
1141	PLCC 11.5x14 (32pins)	15	13	15	10
1188	PLCC 9x9 (20pins)	11	11	10	10
1189	PLCC 34x34 (100pins)	36.5	36.5	33.5	33.5

Small-Outline Package

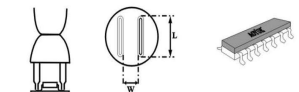

Nozzle Model	IC Package Size (mm)	Nozzle Size (mm)	
		L	W
1131	SOP 4.4x10	10	4.8
1132	SOP 5.6x13	15	6.7
1133	SOP 7.5x15	16	7.2
1134	SOP 7.5x18	19	7.2
1257	SOP 11x21	21	11.7
1258	SOP 7.6x12.7	11.7	8.2
1259	SOP 1.3x28	29	13.5
1260	SOP 8.6x18	19	8.7

Thin Small-Outline

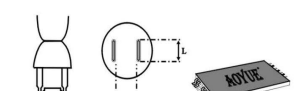

Nozzle Model	IC Package Size (mm)	Nozzle Size (mm)	
		L	W
1185	TSOL 13x10	10	11.9
1187	TSOL 18.5x8	10	18.5
1186	TSOL 18x10	11.7	18.2

Quad Flat Pack

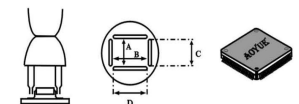

Nozzle Model	IC Package Size (mm)	Nozzle Size (mm)			
		A	B	C	D
1125	QFP 10x10	10.2	10.2	10	10
1126	QFP 14x14	15.2	15.2	15	15
1127	QFP 17.5x17.5	19.2	19.2	19	19
1128	QFP 14x20	15.2	21.2	15	21
1229	QFP 28x28	29.5	29.7	29	29
1215	QFP 42.5x42.5	42.5	42.5	40	40
1261	QFP 20x20	20.2	20.2	21	21
1262	QFP 12x12	12.2	12.2	12	12
1263	QFP 28x40	27.7	39.7	29	39
1264	QFP 40x40	40.2	40.2	39	39
1265	QFP 32x32	32.2	32.2	31	31

Bumpered Quad Flat Pack

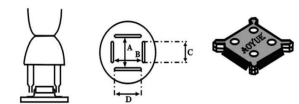

Nozzle Model	IC Package Size (mm)	Nozzle Size (mm)			
		A	B	C	D
1180	BGFP 17x17	18.2	18.2	13.6	13.6
1181	BGFP 19x19	19.2	19.2	16	16
1203	BGFP 35x35	35.2	35.2	30.6	30.6
1182	BGFP 24x24	24.2	24.2	21	21

(*) Sold Separately

REPLACEMENT TIPS

Bevel Type

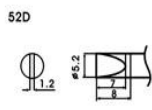
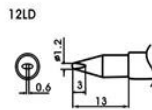
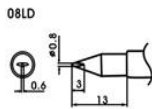
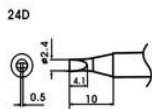
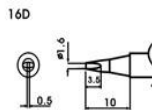
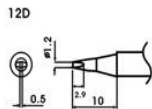
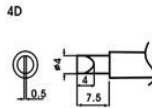
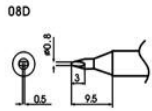

Chisel Type

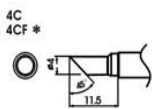
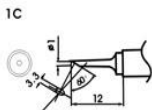
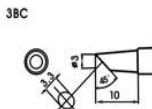
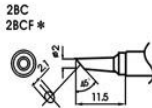
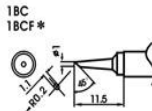

Flow Type

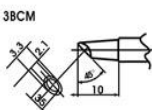
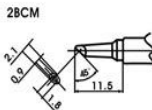

Conical Type

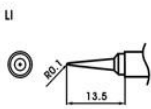
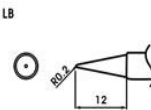
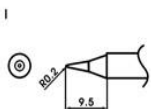
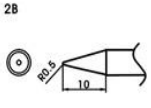
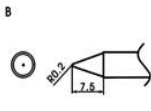

Tunnel Type

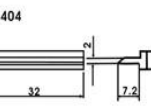
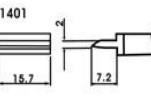

Blade Type

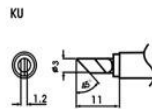
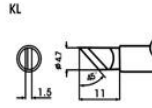
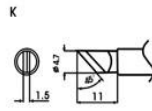

Sharp-Bent Type

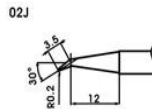

* These tips are finned on the soldering surface only.

(*) Sold Separately

PRODUCT DESCRIPTION

The Aoyue INT2703A+ Advanced Lead-Free Repairing System is a reworking equipment that combines the functionality of Hot Air Gun, Soldering Iron, Smoke Absorber, and Desoldering Gun in one package.

The dual port system of the Int2703A+ allows simultaneous use of the desoldering gun and soldering iron.

The nozzle is specially designed with air spreader technology to disperse heat and air evenly greatly enhancing the heat output for more effective reflows. When paired with our fourth generation BGA nozzle technology, reworking larger BGAs (CPUs GPUs) will be even more efficient and repeatable.

It has several safety features such as the auto-cooling process of the Hot Air Gun. This functionality protects the device (and its components) from excessive heat upon reaching any of the following conditions: (1) when the soldering gun remained idle on its resting handle after a certain period and (2) when the temperature of the device is above a safe threshold upon turning off.

It has several advanced features such as solder iron and desoldering gun digital calibration, configurable auto sleep for the hot-air gun, soldering iron and desoldering gun.

There is an automated function that allow the programming of a 5 segment reworking profile for automated and consistent reflows.

Finally, the unique, innovative design with digital control panel and display provides precision, safety, and ease of use to match all reworking requirements.

SPECIFICATION

MAIN STATION	
Power Input :	available in 110V / 220V
Station Dimensions:	188(w) x 126(h) x 250(d) mm
Weight:	5.6Kg
SOLDERING IRON	
Power Consumption:	70W
Temperature Range:	200°C - 480°C
Heating Element:	Ceramic Heater
Output Voltage:	24V
HOT AIR GUN	
Power Consumption:	500W
Temperature Range:	100°C - 480°C
Heating Element	Metal Heating Core
Pump/Motor Type:	Diaphragm Pump
Air Capacity:	23 l /min (max)
DESOLDERING GUN	
Temperature Range:	200°C - 480°C
Heating Element:	Ceramic Heater
Output Voltage:	24V

Specifications are subject to change without prior notice.

BASIC TROUBLESHOOTING GUIDE

Case 3: The Suction Vacuum cap is connected to the Smoke Absorber Terminal or Vacuum cap instead of the Wire mesh cap.

SOLUTION:

Change the cap to the Wire mesh cap. This allows more air to pass through the system. Make sure as well that the vacuum tube of the soldering iron or desoldering gun is not connected.

Case 4: The Wire mesh cap is connected but airflow level is still low.

SOLUTION:

Check the filter pad inside for dirt that can block the air passage. Clean or replace if necessary.

ADDITIONAL SOLUTION: Check for any tangles in the tube of the hot air gun that can cause the air blockage.

PROBLEM 8: UNIT SHOWS UNCONVENTIONAL BEHAVIOR

Description: Unit operates erratically.

SOLUTION1: Try to switch OFF the device and switch ON again. Unplug the system from the main power source and plug in again when necessary

SOLUTION2: Restore unit to default factory setting. switch off/on the unit while holding the hot-air temperature down button until the banner finishes scrolling, the unit would revert to its default factory setting.

OTHER PROBLEMS NOT MENTIONED:

Contact the vendor.

BASIC TROUBLESHOOTING GUIDE

PROBLEM 6: SOLDERING IRON TEMPERATURE DISPLAY PANEL SHOWS “PLUG” CHARACTERS

Case 1: The system shows “PLUG” from the soldering iron temperature display panel .

SOLUTION 1:Check if the soldering iron connection assembly is properly connected and secured to the receptacle on the control panel.

SOLUTION 2:Make sure the soldering iron tip is properly inserted and secured inside the handle. Loose contacts between the tip and handle can also cause this error message.

SOLUTION 3:See “Soldering Iron Error Messages” on page 21 for further details.

PROBLEM 7: AIR PRESSURE LEVEL IS SIGNIFICANTLY LOW NO MATTER HOW HIGH THE AIRFLOW LEVEL IS CALIBRATED

Case 1: Check the mains voltage (AC power source). If the voltage level falls significantly low, about 15-20% lower than the standard, there will also be a noticeable drop in the air pressure level.

SOLUTION:

Please refer to your local power service provider.

Case 2: The microcontroller might have detected the operating frequency incorrectly. The user will notice that airflow level is weaker with reference to the airflow gauge compared with the displayed value.

SOLUTION:

Turn off the unit and on again to let the device re-detect the proper operating frequency

PACCKAGE INCLUSIONS

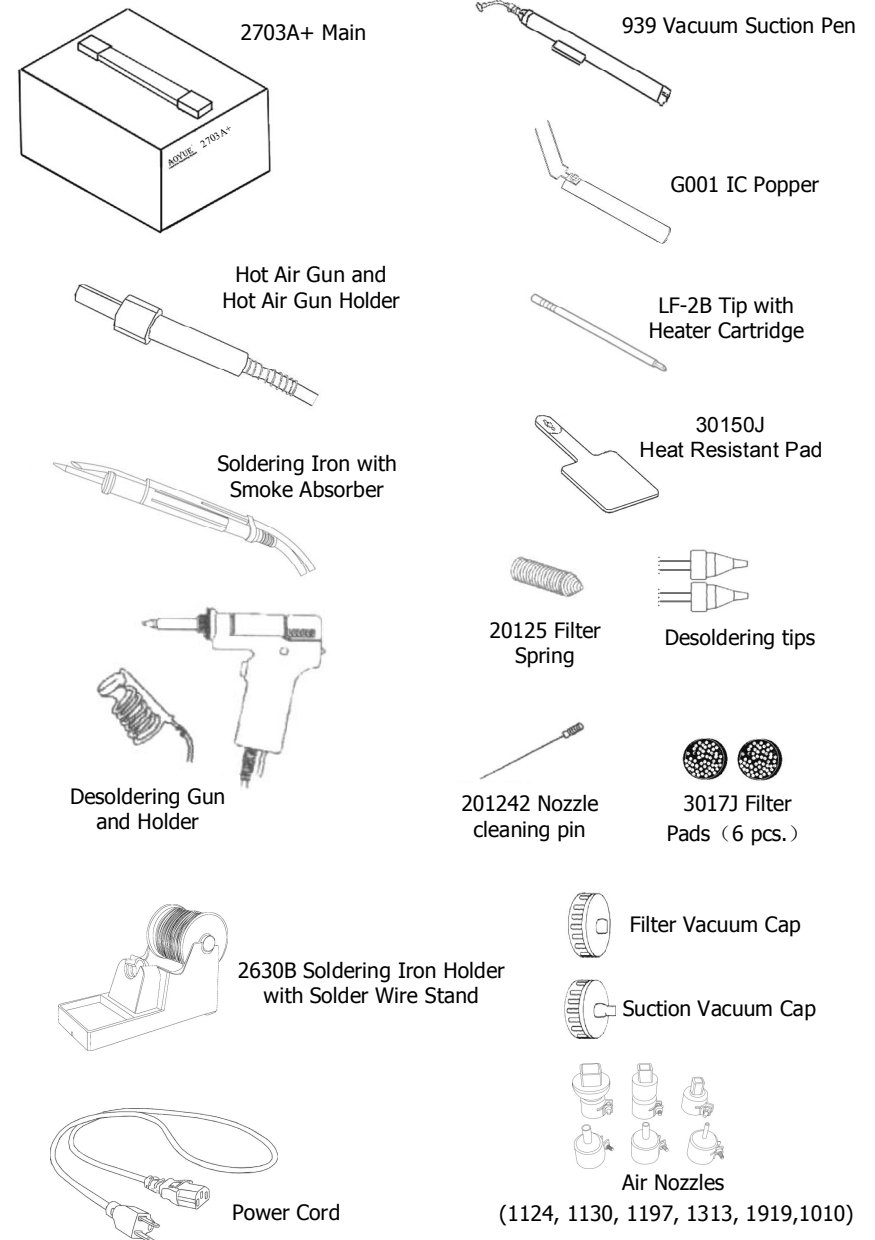

FUNCTION and FEATURES

- Microprocessor-controlled ESD safe equipment.
- 3-in-1 repairing system combining Hot Air Gun, Soldering Iron, and Desoldering Gun in one sophisticated package.
- Advance technology air spreader nozzle
- Digital control and display of hot air temperature, soldering iron temperature, desoldering gun temperature and air pressure with touch type panel controls for precision and ease of use.
- The desoldering gun is equipped with air cylinder type vacuum pump for stronger suction and zero-crossing circuit that prevents electrical surges.
- Integrated smoke absorber functionality with filter pad to efficiently absorb and filter harmful fumes.
- Automated reflow function with 5 segment programmable profile.
- Uniquely designed compound tip that integrates the ceramic heating element and sensor in just one component. Replacing tips is as easy as slipping it in/out of the compatible 24V soldering iron.
- User configurable 1 to 60 minute idle-to-auto-sleep mode for additional device protection and power saving.
- Built-in auto-cooling process that protects the system and its components from excessive heat, prolonging usage life.
- Large selection of air nozzles.
- Compatibility with different kind of soldering tips.

BASIC TROUBLESHOOTING GUIDE

PROBLEM 1: THE UNIT HAS NO POWER

1. Check if the unit is switched ON.
2. Check the fuse. Replace with the same type if fuse is blown.
3. Check the power cord and make sure there are no disconnections.
4. Verify that the unit is properly connected to the power source.

PROBLEM 2: HOT-AIR GUN TEMPERATURE DISPLAY IS ALWAYS ABOVE 500°C

Description: Constant display of above 500°C temperature from the panel then displays an “Err1” on the panel after a few minutes.

SOLUTION:

The thermal sensor may be broken and needs to be replaced.

PROBLEM 3: HOT-AIR GUN ACTUAL AIR TEMPERATURE IS NOT INCREASING

Description: Actual temperature reading is not increasing or decreasing based on desired level.

SOLUTION:

The heating element may be broken or is at the end of its life and needs to be replaced.

PROBLEM 4: THE UNIT IS VIBRATING TOO MUCH

SOLUTION: Check if the 4 screws that hold the pump in place are properly and tightly connected. Unplug the system from the main power source before opening the case to check inside the station.

PROBLEM 5: THE UNIT IS VERY NOISY

SOLUTION:

Make sure the screw at the center of the base of the main unit has been removed. This holds the pump in place during transportation and needs to be removed before using the equipment.

CARE and MAINTENANCE

Changing nozzle:

- Unscrew the securing lock and pull out the heater external housing together with the securing lock, Nozzle can now be changed. Re-secure nozzle by tighten the securing lock on its receptacle.

Changing Filter pad and Filter Spring:

- Unlock the filter dock by toggling the filter dock locking mechanism. The filter dock would push out to allow easy extraction of the filter barrel assembly which houses the filter pad, filter spring and filter barrel cap.

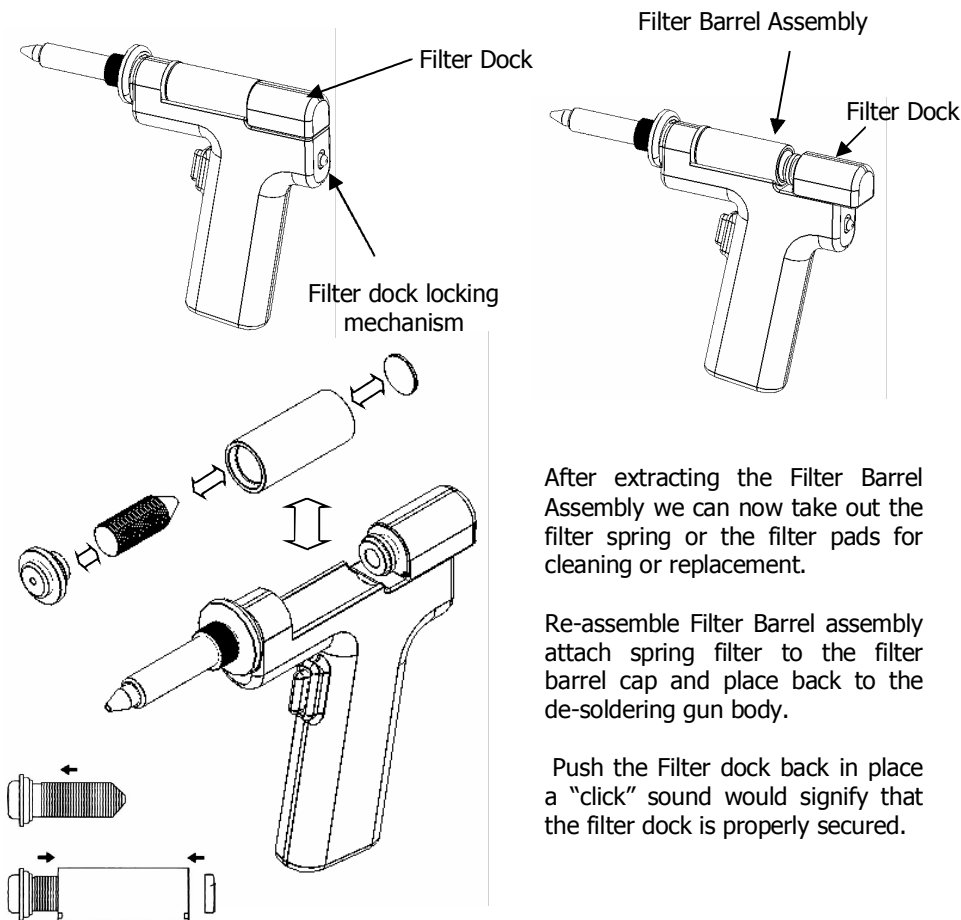

SAFETY PRECAUTIONS

CAUTION: Improper usage can cause serious injury to personnel and/or damage to equipment. For your own safety, please observe the ff. precautions.

- Check each component after opening the package to make sure everything is in good condition. If there are any suspected damage, do not use the item and report the issue to your vendor.
- Turn OFF the main power switch and unplug the device when moving the device from one location to another.
- Do not strike or subject the main unit to physical shock. Use carefully to avoid injury and damage to any part.
- Handle with care.
 - Never drop or sharply jolt the unit.
 - Contains delicate parts that may break if the unit is dropped.
- Make sure the equipment is always grounded. Always connect power to a grounded receptacle.
- Temperature may reach as high as 480°C when switched ON.
 - Do not use the device near flammable gases, paper and other flammable materials.
 - Do not touch heated parts, which can cause severe burns.
 - Do not touch metallic parts near the tip.
- Disconnect the plug from the power source if the unit will not be used for a long period.
 - Turn off power during breaks, if possible.
- Use only genuine replacement parts.
 - Turn off power and let the unit cool before replacing parts.
- The unit may produce a small amount of smoke and unusual odor during initial usage. This is normal and should not yield any negative result when reworking.
- Soldering process produces smoke — use on well ventilated place.
- Do not alter the unit, specifically the internal circuitry, in any manner.

ASSEMBLY and PREPARATIONS

A. Main Station

As soon as the equipment has been removed from the package, **REMOVE THE SCREW** located at the center of the bottom of the main unit. This screw holds the pump in place during transportation.

WARNING: Failure to remove the screw before using the equipment can cause damage to the system.

B. Soldering Iron

1. Install the solder wire to the soldering iron holder as in Figure 1.

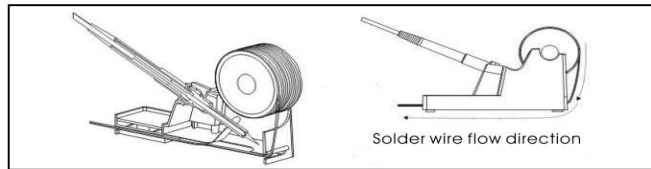

Figure 1. Soldering iron stand with solder wire holder

2. Connect the soldering iron cord assembly to the 6-pin output terminal found at the lower middle portion of the main unit.
3. Place the soldering iron to the soldering iron stand as shown above.

C. Smoke Absorber

1. Attach the smoke absorbing tube to the suction vacuum cap. Make sure the cord connections are free from tangles.

D. Hot Air Gun

The Hot Air Gun holder was installed on the station upside down for packaging purpose. To set up the Hot Air Gun holder:

1. Loosen the two screws that secure the holder to the station.
2. Turn the holder right side up.
3. Re-fasten the two screws.
4. Place the hot air gun onto the holder in preparation for usage.

E. Desoldering Gun

1. Connect the cord of the desoldering gun to the 6-pin terminal .
2. Connect the vacuum tube to the suction vacuum cap.
3. Place the desoldering gun onto the holder in preparation for usage.

CARE and MAINTENANCE

4. Inside the pipe, the quartz glass and heat insulation are installed. Loosen the cable and take out the heating element.
5. Insert new heating element and reconnect the terminal. *Be careful not to rub Heating Element wire.*
6. Reconnect the ground wire after replacing the element.
7. Assemble the handle again.

Soldering Iron Error Messages

1. Soldering Iron connection assembly is not connected or not properly connected to the receptacle on the control panel.
2. Soldering iron tip is damaged and needs to be replaced. The device will display "PLUG".
3. Indicating a problem with the contacts of the soldering iron or the tip.

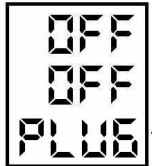

De-Soldering Gun

1. Before usage dampen the filter pads with a little bit of water to allow efficient air passage and filter action, re-dampen pads frequently for maximum efficiency.
2. Routinely clean Spring Filter, and replace filter pads when they are dirty or clogged .
3. The solder pathway can be cleaned using the provided Nozzle cleaning pin, use the cleaning pin when pathway seems clogged.

De-Soldering Gun Disassembled illustration:

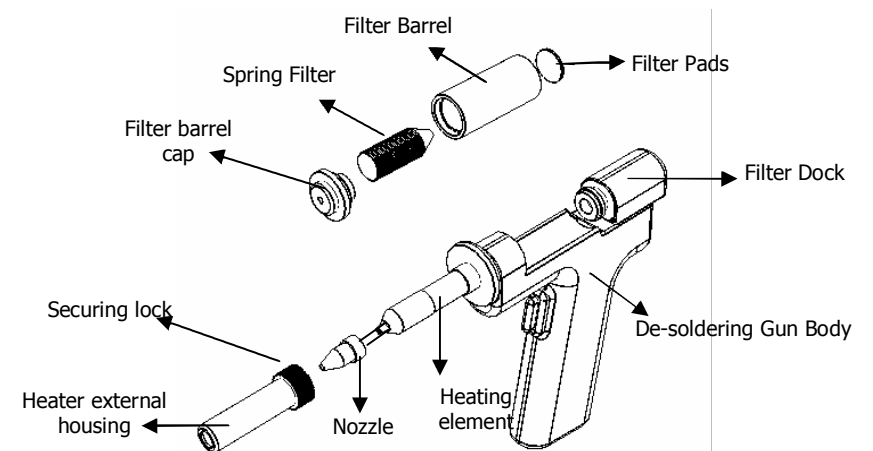

CARE and MAINTENANCE

Spare Parts Guide

Part No.	Description
10094	Hot air gun heating element
30106S	Plastic handle of hot air gun
S009	Hot air gun complete handle
20962	Hot air gun metal pipe
B012	Soldering Iron complete handle
C005	Desoldering gun heating element
3072D	Plastic handle of desoldering gun
B1003	Desoldering gun complete handle

Blower/Vacuum Air Terminal Filters

Filters should be cleaned and replaced regularly to avoid dirt which can clog the air passage. More importantly, this will also effectively clean the toxic fumes produced during soldering process.

Soldering Iron Tip

Always keep the solder-plated section of the tip/nozzle coated with a small amount of solder. Oxide coating on the tip of the nozzle reduces its heat conductivity. Coating the tip with a small amount of fresh solder ensures maximum heat conductivity is obtained.

Replacing the Soldering Iron tip

1. Always turn OFF main power switch when removing or inserting a tip.
2. If the tip is hot, use the heat resistant pad to pull it out.
3. Insert the new tip fully into the handle. If the tip is not fully inserted (or if the tip is damaged), the device will display "PLUG". Indicating a problem with the contacts of the soldering iron or the tip.

Replacing the heating element of the Hot Air Gun

The heating element is found in the middle part of the hot air gun. The normal life of a heating element is 1 year under normal operating conditions.

Steps:

1. Loosen the 3 screws that secure the handle.
2. Slide off the plastic tube.
3. Disconnect the ground wire sleeve.

CONTROL PANEL GUIDE

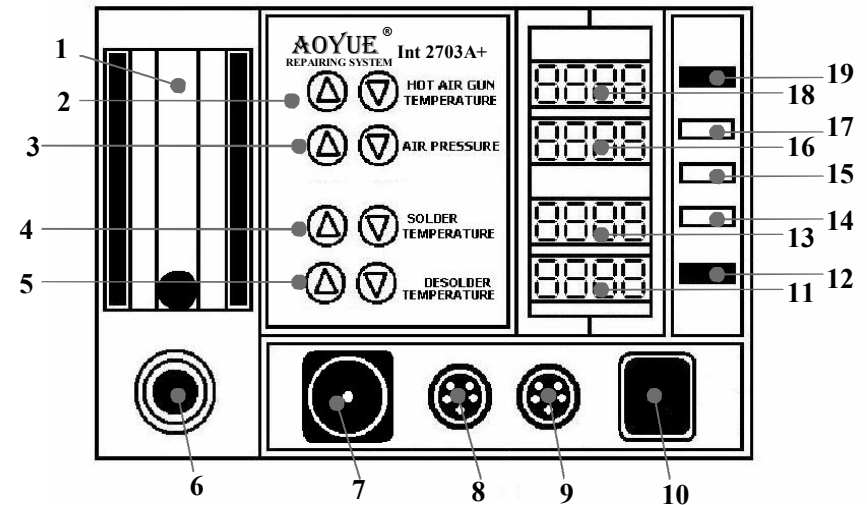

LEGEND:

- 1 — Airflow Gauge
- 2 — Hot Air Gun Temperature Adjustment Buttons
- 3 — Hot Air Gun Airflow Adjustment Buttons
- 4 — Soldering Iron Temperature Control Buttons
- 5 — Desoldering Gun Temperature Control Buttons
- 6 — Hot Air Gun Output Terminal
- 7 — Smoke Absorber Terminal or Vacuum Cap
- 8 — Soldering Iron Receptacle
- 9 — Desoldering Gun Receptacle
- 10 — Main Power Switch
- 11 — Desoldering Gun Temperature Display
- 12 — Desoldering Gun Function Activation Switch
- 13 — Soldering Iron Temperature Display
- 14 — Soldering Iron Function Switch
- 15 — Smoke Absorber Function Switch
- 16 — Hot Air Gun Air flow Display / Automate Display
- 17 — Hot Air Gun Automate Function Selector
- 18 — Hot Air Gun Temperature Display /Automate Display
- 19 — Hot Air Gun Function Switch

OPERATING GUIDELINES

IMPORTANT REMINDERS:

1. Make sure the equipment is placed on a flat stable surface and all the heat-generating components placed on their respective holders or stands.
2. Ensure all function switches are OFF prior to reworking.
3. Ensure all terminal connections are properly secured.

IMPORTANT: Please refer to the **CONTROL PANEL GUIDE** page for buttons and display panel directory.

A. INITIAL PROCEDURES

1. Plug the device to the main power source using the power cord provided in the package.
2. With all function switches deactivated and all terminal connections properly secured, switch ON the device by activating the main power switch ("10" from the control panel).
3. The display panels, will temporarily show the product name "AOYUE Int 2702" and then display "OFF". The system will remain at this state until the user activates a function.

B. HOT AIR GUN

1. Follow the initial procedures above, "**A. INITIAL PROCEDURES**".
2. Activate "Hot Air Gun" switch ("19" from the control panel).
3. The system will immediately start to blow air at an airflow rate of **50** while rapidly and safely increasing the air temperature to **100°C** (default system operating parameters). These values will be reflected from the Hot Air Gun Air Temperature and Air Pressure display panels, "18" and "16" from the control panel, respectively. The metal ball inside the air gauge ("1" from the control panel) will also settle somewhere in the middle of the visible area indicating that the system is blowing air at an average or normal rate.

DIGITAL CALIBRATION

Solder Iron Digital Temperature Calibration Example

- The external temperature sensor displays 250 degrees.
- The set temperature and displayed actual temperature of the soldering iron is 300 degrees.
- $300 - 250 = 50$. An additional adjustment of 50 degrees is required. Upon entering calibration mode, the display shows "010", indicating a calibration number of 10 is already present.
- Therefore $10 + 50 = 60$.
- We adjust from "010" to "060" by pressing the up button of the Soldering Iron Temperature Adjustment button ("4" from the control panel)
- Save and exit calibration mode.
- The external temperature sensor would now display 298 to 302.

Desoldering Gun Digital Temperature Calibration Example

- The external temperature sensor displays 300 degrees.
- The set temperature and displayed actual temperature of the soldering iron is 350 degrees.
- $300 - 350 = -50$. An additional adjustment of -50 degrees is required. Upon entering calibration mode, the display shows "010", indicating a calibration number of 10 is already present.
- Therefore $10 - 50 = -50$.
- We adjust from "010" to "050-" by pressing the down button of the Desoldering Gun Temperature Adjustment button ("5" from the control panel)
- Save and exit calibration mode.
- The external temperature sensor would now display 298 to 302.

NOTES:

- Calibration will only make the newly calibrated point the most accurate. Other temperature points may be a little off.

DIGITAL CALIBRATION

I. Utilizing the Desoldering Gun Digital Temperature Calibration

1. Turn on the Desoldering gun function switch.
2. Set to appropriate temperature you want to calibrate. Place the tip of the desoldering gun on an external temperature meter.
3. The readings on the external temperature sensor should be more or less equal to the displayed temperature.
4. If there are large discrepancy in the temperature reading we can re-calibrate the temperature setting. First write down the set temperature of the soldering iron and the actual temperature reading from the external temperature meter.

For example:

Set temperature = **300**

external temperature = **350**

5. Turn off the Soldering Iron Function switch ("14" from the control panel) .Ensure that the Desoldering Gun Function switch is in the off position("12" from the control panel) .
6. Press and hold the **UP** button of the Soldering Iron Temperature Adjustment button ("4" from the control panel) .
7. The Desoldering Gun Temperature Display ("14" from the control panel) . Will switch to four zeros "000" indicating it is now in the desoldering gun temperature calibration mode. Release the **UP** button of the Soldering Iron Temperature Adjustment button ("4" from the control panel) .
8. Use the Desoldering Gun Temperature Adjustment buttons ("5" from the control panel) to increase or decrease the calibration values. In our example the set temperature is 300 but the actual temperature is 350, There is a difference of -50 degrees. Press the up button until we reach "050- ".
9. Confirm the change by pressing and holding the "**UP**" button of the Soldering Iron Temperature Adjustment button ("4" from the control panel).

OPERATING GUIDELINES

4. Adjust the air flow level using the AIR PRESSURE ADJUSTMENT BUTTONS ("3" from the control panel).
5. Adjust the hot air gun air temperature using the HOT AIR GUN TEMPERATURE ADJUSTMENT BUTTONS ("2" from the control panel). The prefix of the display for Hot Air Gun Temperature will change from "C" to "c" indicating that air temperature is being adjusted. It will return to "C" indicating actual temperature is displayed.
6. Reworking task can be started 1 minute after the desired hot air

 **IMPORTANT:** When adjusting the air temperature, it is strongly advised to initially increase the airflow level in order to manage the system temperature. This is to protect the heating element inside the handle from excessive heat and avoid the possibility of subjecting adjacent components to thermal shock.

temperature and airflow level are reached, as also indicated from display panel "18" .

7. When reworking is complete, return the Hot Air Gun to its holder but **DO NOT** immediately turn off the main power switch.
8. Deactivate the Hot Air Gun Activation button first in order to activate the auto-cooling process. The system will start to blow air (at room temperature) at a fast rate to reduce heat from the hot air gun and bring down the temperature to a reasonable safe level of **90°C**. During this time, the air flow display will also change "cool" while temperature is gradually decreasing. Once the temperature drops to approximately **90°C** the system will halt and display "OFF" on the panel. It is now safe to switch off the main power switch.
9. Turn OFF the main power switch.
10. Unplug the device from the main power source.

OPERATING GUIDELINES

C. AUTOMATE FUNCTION

The system is equipped with a 5 stage automated hot air rework profiling system. To access and change the time and temperature settings of the profile follow the guide below:

1. Ensure that the hot air gun function switch is deactivated.
2. The Hot Air Gun Automate Function Selector ("17" from the control panel) allows us to scroll thru the different stages of the profile. The stages use the symbols A, b, c, d and E, to indicate stages 1 to 5 respectively. The Automate Display ("18" from the control panel) shows the desired temperature for each stage and the Automate Display ("16" from the control panel) shows the duration at which the set temperature is to be maintained.
3. Now press the Hot Air Gun Automate Function Selector, the display will change to "###A," and "###t". The suffix A indicates that we are now adjusting the desired temperature for stage 1. The suffix "t" indicates the time in seconds the desired temperature is to be maintained.
4. Use the Hot Air Gun Temperature Adjustment Buttons to select the desired temperature for this stage. Use the Hot Air Gun Airflow Adjustment Buttons to select the desired duration. Adjust the temperature/ duration of the other stages. Simply press the Hot Air Gun Automate Function Selector to scroll to the next stage. Then use the respective keys to adjust temperature and duration.
5. To save the newly inputted profile into memory, repeatedly press the Hot Air Gun Automate Function Selector until the display shows "SAUE". Press the up button of the Hot Air Gun Temperature Adjustment Button to confirm saving of the profile.

DIGITAL CALIBRATION

H. Utilizing the Solder Iron Digital Temperature Calibration

By default, the system is properly calibrated but for some cases when a little adjustment of the soldering iron temperature is required the following procedure can be done.

1. Turn on the soldering iron function switch.
2. Set to appropriate temperature you want to calibrate. Place the tip of the soldering iron on an external temperature meter.
3. The readings on the external temperature sensor should be more or less equal to the displayed temperature.
4. If there are large discrepancy in the temperature reading we can re-calibrate the temperature setting. First write down the set temperature of the soldering iron and the actual temperature reading from the external temperature meter. For example:

set temperature = **350**

external temperature = **300**

5. Turn off the Soldering Iron Function switch ("14" from the control panel). Ensure that the Desoldering Gun Function switch is in the off position ("12" from the control panel).
6. Press and hold the **UP** button of the Desoldering Gun Temperature Adjustment button ("5" from the control panel).
7. The Soldering Iron Temperature Display ("11" from the control panel) will switch to four zeros "000" indicating it is now in the soldering iron calibration mode. Release the **UP** button of the Desoldering Gun Temperature Adjustment button.
8. Use the Soldering Iron Temperature Adjustment buttons ("4" from the control panel) to increase or decrease the calibration values. In our example the set temperature is 350 but the actual temperature is 300, There is a difference of 50 degrees. Press the up button until we reach "050".
9. Confirm the change by pressing and holding the **"UP"** button of the Desoldering Gun Temperature Adjustment button ("5" from the control panel).

AUTO SLEEP FUNCTIONS

Changing SLEEP Timer (Desoldering Gun)

By default, the system's sleep duration is 0 indicating the sleep timer is disabled. To activate the sleep function follow the procedures.

1. Turn off the Soldering Iron Function switch ("14" from the control panel) .Ensure that the Desoldering Gun Function switch is in the off position("12" from the control panel) .
2. Press and hold the **DOWN** button of the Soldering Iron Temperature Adjustment button ("4" from the control panel) .
3. The Desoldering Gun Temperature Display ("14" from the control panel) . Will switch to "000t" indicating it is now in the desoldering gun sleep timer adjustment mode. Release the **DOWN** button of the Soldering Iron Temperature Adjustment button
4. Use the Desoldering Gun Temperature Adjustment buttons ("5" from the control panel) to increase or decrease the sleep duration. Timer is adjustable from 1 to 60 minutes, a value of 0 indicates that the sleep timer function is turned off.
5. Confirm the change by pressing and holding the **UP** button of the Soldering Iron Temperature Adjustment button ("4" from the control panel).

OPERATING GUIDELINES

To start the automated reworking function, Follow the guide below:

1. Ensure that the hot air gun function switch is deactivated.
2. Press the Hot Air Gun Automate Function Selector ("17" from the control panel) until the display shows "run".
3. Press the up button of the Hot Air Gun Temperature Adjustment Button to initiate the automated reworking function.

Upon the start of the automated reworking function the hot air gun would slowly heat up until it reaches the set temperature of segment A. After the set temperature is reached it would maintain the set temperature for the duration as set in segment A. The displayed duration will start counting down until the timer reaches 0 after which it will proceed to the next segment, repeating the process until it finishes all 5 segments. Upon the end of the fifth segment the cool down function will be activated to automatically cool down the system before shutting off.

NOTES:

1. Hot Air Gun Temperature is adjustable between **100°** and **480°C** .
2. Hot Air Gun Airflow Rate is adjustable between **15** and **100**.
3. The hot air gun is equipped with a temperature limiting feature to only allow a temperature rise of 3 degrees per second. This is in accordance with the industry standard allowable temperature rise time to prevent damage to sensitive components.

OPERATING GUIDELINES

D. SOLDERING IRON

1. Connect the Soldering Iron connection assembly to the 6-pin receptacle located at the front of the control panel ("9" from the CONTROL PANEL GUIDE).
2. Follow the initial procedures ("**A. INITIAL PROCEDURES**").
3. Connect the vacuum tube to the Smoke Absorber Terminal or Vacuum Cap ("7" from the control panel). If smoke absorber function is to be used.
4. Activate the "SOLDER IRON" Activation switch ("14" from control panel). This will automatically start to increase the temperature of the soldering iron to **350°C** (default).
5. Adjust the soldering iron temperature using the SOLDER/DESOLDER TEMPERATURE ADJUSTMENT buttons ("4" from the control panel).
6. If smoke absorber function is to be used. Activate the "SMOKE ABSORBER" Activation switch ("15" from the control panel).
7. Start using the soldering iron as soon as desired temperature is reached.
8. When the task is finished, deactivate the SMOKE ABSORBER switch.
9. Deactivate the SOLDER IRON activation switch.
10. Allow sufficient time for the soldering iron to cool down before keeping in a safe storage.

D. DESOLDERING GUN

1. Connect the De-soldering gun connection assembly to the 6-pin receptacle located at the front of the control panel ("8" from the CONTROL PANEL GUIDE).
2. Follow the initial procedures ("**A. INITIAL PROCEDURES**").
3. Connect the vacuum tube to the Smoke Absorber Terminal or Vacuum Cap ("7" from the control panel).

AUTO SLEEP FUNCTIONS

NOTES:

- The sleep mode timer is configurable between **1** and **60** minutes.
- A sleep mode timer value of "**0**" disables the sleep function.
- Sleep mode settings for Hot-Air gun is saved into the memory and shall remain in effect until it is reset or new data is entered.

G. Auto-Sleep Mode (Soldering Iron and Desoldering Gun)

The device has a built-in auto-sleep feature to conserve power enhance the heater life. The sleep timer can be configured to power down the soldering iron or desoldering gun after a defined time. When in sleep mode four dashes " - - - - " will be shown indicating that it is now in sleep mode. To reactivate the soldering iron or desoldering gun simply push the its function button or its temperature adjustment button.

Changing SLEEP Timer (Soldering Iron)

By default, the system's sleep duration is 0 indicating the sleep timer is disabled. To activate the sleep function follow the procedures.

1. Turn off the Soldering Iron Function switch ("14" from the control panel) .Ensure that the Desoldering Gun Function switch is in the off position("12" from the control panel) .
2. Press and hold the **DOWN** button of the Desoldering Gun Temperature Adjustment button ("5" from the control panel) .
3. The Soldering Iron Temperature Display ("14" from the control panel) . Will switch to "000t" indicating it is now in the soldering iron sleep timer adjustment mode. Release the **DOWN** button of the Desoldering Gun Temperature Adjustment button
4. Use the Soldering Iron Temperature Adjustment buttons ("4" from the control panel) to increase or decrease the sleep duration. Timer is adjustable from 1 to 60 minutes, a value of 0 indicates that the sleep timer function is turned off.
5. Confirm the change by pressing and holding the "**DOWN**" button of the Desoldering Gun Temperature Adjustment button ("5" from the control panel).

AUTO SLEEP FUNCTIONS

F. Auto-Sleep Mode (Hot Air Gun)

The device has a built-in auto-sleep mode feature such that if the Hot Air Gun sits on its handle and remained idle after a certain period the prefix of the display for Hot Air Gun air temperature will also change from "C" to "d" , the device will switch to sleep mode. This mechanism is triggered by a countdown timer. When the timer has elapsed, the system will blow air (at room temperature) at maximum rate in order to bring down the temperature. During this time, the Hot Air Gun air level display will change to "cool". Once the temperature drops to approximately 90° C, the Hot Air Gun will automatically stop and show four dashes " - - - - " indicating that the system is now in sleep mode. To reactivate the hot air gun simply press pick up the hot air gun from its dock.

Changing SLEEP Mode Timer (HOT AIR GUN)

By default, the system has 15-minute countdown time before the hot air gun goes to sleep mode. This can be altered by the following procedure.

1. While the hot air gun is on stand-by mode ("OFF" is displayed on the panels "18" and "16"), Press and hold the **UP** button of the HOT AIR GUN AIRFLOW adjustment button("3" control panel) .
2. Wait until "015d" is displayed on the Hot Air Gun Temperature display panel, "18".
3. Release the button when "005d" appears.
4. Adjust the time using the **UP** and **DOWN** buttons of the HOT AIR GUN TEMPERATURE adjustment buttons ("2" control panel).
5. Confirm the change by pressing and holding the **DOWN** button of the HOT AIR GUN AIRFLOW adjustment button. ("3" from control panel guide)
6. The system will switch back to displaying "OFF" indicating the new sleep timer is saved into the system.

OPERATING GUIDELINES

4. Activate the "DESOLDER GUN" Activation switch ("12" from control panel). This will automatically start to increase the temperature of the desoldering gun to **350°C** (default).
5. Adjust the desoldering gun temp. using the DESOLDER TEMPERATURE ADJUSTMENT buttons ("5" from the control panel).
6. Allow the desoldering gun's tip and its barrel to heat up. Tip temperature can be reached within 5-6 minutes and its barrel would obtain optimum temperature 5-9 minutes after the tip temperature has been reached. If upon initial use solder gets stuck at the end of the barrel, clean the barrel and wait a few more minutes for the barrel to heat up.
7. Check the tip temperature with an external temperature sensor, adjust temperature settings higher or lower for the right temperature. Or recalibrate at the desired temperature level
8. Ensure that all the solder is melted before triggering the pump. (Partially melted solder will still be sucked up however it would clog the barrel).
9. Upon pressing the pump trigger hold the trigger for 1 to 2 seconds longer, as larger lumps of solder may need a longer suction time to clear the barrel and go into the filter.
10. Clean the filter and dampen the sponge frequently during and after usage to allow better suction power.
11. When the task is finished, deactivate the DESOLDER GUN function switch. Allow the desoldering gun to cool down before handling for storage.

Notes:

- Please follow the procedures and tips presented above for more efficient usage of the desoldering gun.
- Industry recommended tip temperature for soldering is 600 to 610F (315 to 320C) for standard solders and 650 to 700F (340 to 370) for unleaded solders

OPERATING GUIDELINES

- The soldering iron and desoldering gun operating temperature is configurable between 200°C and 480°C
- Because of the difference in the heating element and size of the soldering iron tip and desoldering gun, the soldering iron will heat up faster than the desoldering gun. This is normal and does not have any impact on the system's performance.
- There will be a slight drop in temperature display once the trigger of the desoldering gun is used. This is due to rapid intake of air in which temperature is significantly cooler than the desoldering gun tip. When the system detects this, it will automatically adjust the temperature to compensate for the temperature difference.



NOTICE: When using the desoldering gun and soldering iron simultaneously, the smoke absorbing function of the soldering iron will be deactivated. This it to give priority to the desoldering gun.

OPERATING GUIDELINES

E. Hot Air Gun Safety Feature

The systems' hot air gun has a safety feature to limit the temperature rise to no more than 3 degrees per second. The 3 degrees per second limit is an industry standard recommendation to minimize component damage due to a rapid increase of temperature. This protection feature is activated by default and can be deactivated if desired. Below are the procedures on activation/deactivation of this safety feature:

1. Turn "OFF" system and ensure all function switches are in "OFF" position.
2. Press and hold this two buttons. The Hot Air Gun Automate Function Selector ("17" from the control panel) and the **UP** button of the DESOLDER GUN TEMPERATURE adjustment button. ("5" from the control panel) .
3. With the two buttons held in the pressed position turn "ON" the system by switching the Main Power Switch ("10").
4. Release the buttons when "**SAFE OFF** " appears on the Hot Air Gun Temperature Display/Hot Air Gun Airflow Display . Release the buttons when this is displayed.
5. The display below the word "**SAFE**" will indicate whether the safety feature in "**On**" or "**OFF**" by displaying the corresponding word on the Hot Air Gun Airflow Display . The system will proceed to standby mode.
6. To switch the safety feature "On" or "OFF" simply repeat steps 1 to 5.
7. The Status of the safety feature shall remain in effect until it is manually changed by following procedure 1 to 5.